



BAILIDACN

LED LINEAR LIGHT

BAILIDA CO.,Ltd



LS3050 Linear light

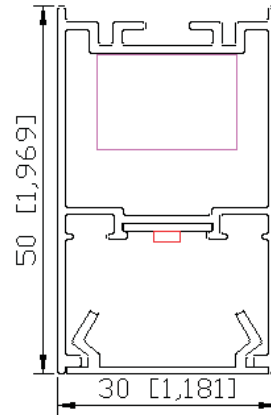

Lamp type: Suspended, Surface mounted,

Input Voltage: 100-277V, LED Source: OSRAM 2835LED, Lumen: >90 lm/w Color tolerance <3.

Driver: built-in isolation driver, anti-flicker /0-10v dimming/ triac dimmer/DALI dimming

Structure: Split type lamp meets all kinds of construction requirements.

Optics: Imported frosted pc diffuser with inner stripe, anti-glare.

Shell: 6063-T5 Aluminum Colors (black, white) and sizes can be customized.

Life span up to 30000 hours, warranty for 3 years.

Certificates: CE, SAA, CCC.

Item number	Power	TCC	Flux(lm)	Dimension	Master carton dimension	QTY
LS3050-06T10	10W		850lm	600mmx30mmx50mm	630mmx290mmx200mm	
LS3050-12T20	20W	3000K	1700lm	1200mmx30mmx50mm	1230mmx290mmx200mm	
LS3050-15T25	25W	4000K	2150lm	1500mmx30mmx50mm	1530mmx290mmx200mm	12
LS3050-18T30	30W	5000K	2550lm	1800mmx30mmx50mm	1830mmx290mmx200mm	
LS3050-24T40	40W	6000K	4300lm	2400mmx30mmx50mm	2430mmx290mmx200mm	

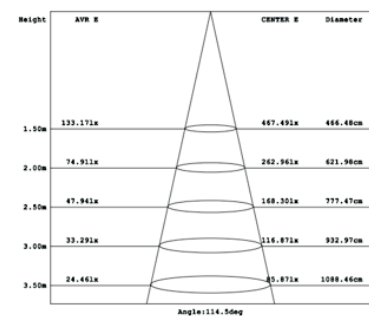
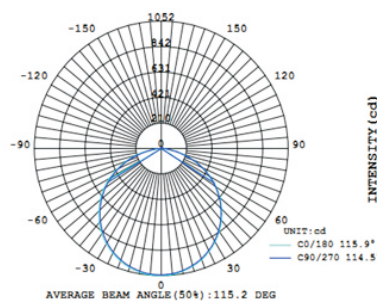
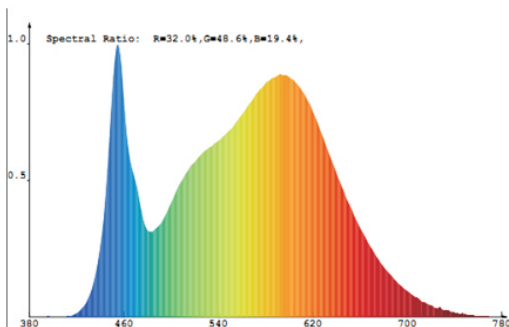

LS5175 Linear light

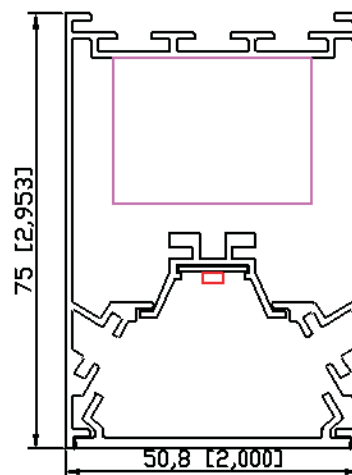
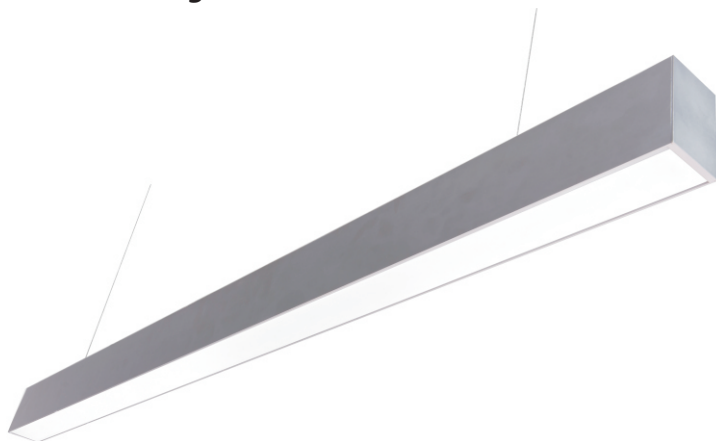

Lamp type: Suspended, Surface mounted, Trimless recessed mounted .

Input Voltage: 100-277V, LED Source: OSRAM 2835LED, Lumen:>105 lm/w Color tolerance<3.

Driver: built-in isolation driver, anti-flicker /0-10v dimming/ triac dimmer/DALI dimming

Structure: Split type lamp meets all kinds of construction requirements.

Optics: Imported frosted pc diffuser with inner stripe, anti-glare.

Shell: 6063-T5 Aluminum Colors (black, white) and sizes can be customized.

Life span up to 50000 hours, warranty for 5 years.

Certificates: cETLs, CE,SAA,CCC,DLC

Item number	Power	TCC	Flux(lm)	Dimension	Master carton dimension	QTY
LS5175-06T15	15w		1580lm	600mmx50.8mmx75mm	630mmx290mmx200mm	
LS5175-12T30	30w	3000K	3150lm	1200mmx50.8mmx75mm	1230mmx290mmx200mm	
LS5175-15T38	38w	4000K	4000lm	1500mmx50.8mmx75mm	1530mmx290mmx200mm	9
LS5175-18T45	45w	5000K	4750lm	1800mmx50.8mmx75mm	1830mmx290mmx200mm	
LS5175-24T60	60w	6000K	6300lm	2400mmx50.8mmx75mm	2430mmx290mmx200mm	

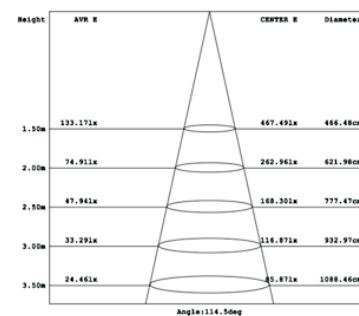
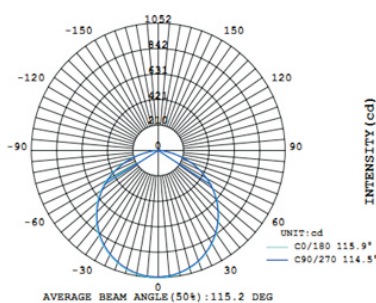
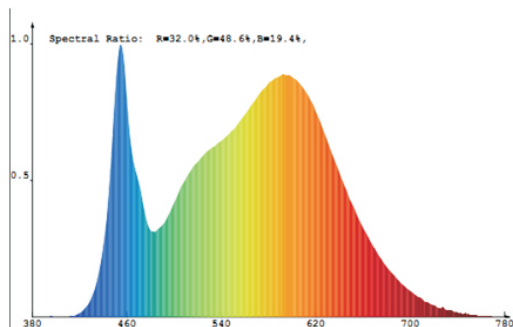

LS6880 Linear light

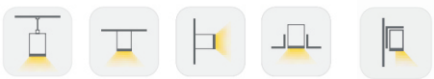
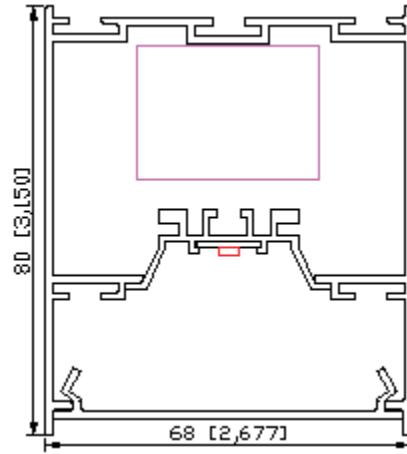

Lamp type: Suspended, Surface mounted, Trimless recessed mounted .

Input Voltage: 100-277V, LED Source: OSRAM 2835LED, Lumen:>105 lm/w Color tolerance<3.

Driver: built-in isolation driver, anti-flicker /0-10v dimming/ triac dimmer/DALI dimming

Structure: Split type lamp meets all kinds of construction requirements.

Optics: Imported frosted pc diffuser with inner stripe, anti-glare.

Shell: 6063-T5 Aluminum Colors (black, white) and sizes can be customized.

Life span up to 50000 hours, warranty for 5 years.

Certificates: CE,SAA,CCC,

Item number	Power	TCC	Flux(lm)	Dimension	Master carton dimension	QTY
LS6880-06T15	15W		1620lm	600mmx68mmx80mm	630mmx290mmx200mm	
LS6880-12T30	30W	3000K	3240lm	1200mmx68mmx80mm	1230mmx290mmx200mm	
LS6880-15T38	38W	4000K	4104lm	1500mmx68mmx80mm	1530mmx290mmx200mm	6
LS6880-18T45	45W	5000K	4860lm	1800mmx68mmx80mm	1830mmx290mmx200mm	
LS6880-24T60	60W	6000K	6480lm	2400mmx68mmx80mm	2430mmx290mmx200mm	

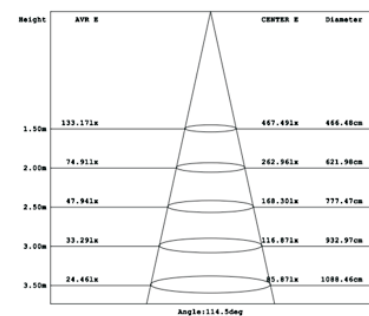
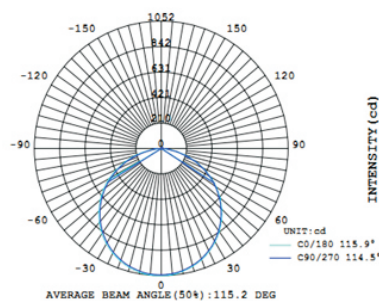
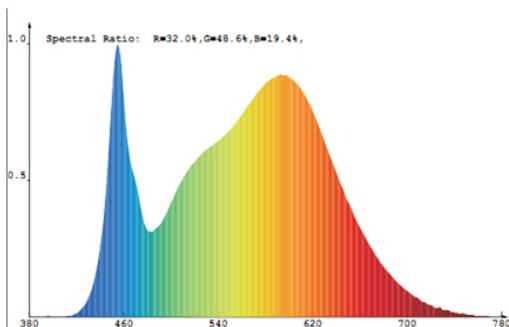

LS7676 Linear light

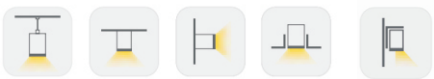
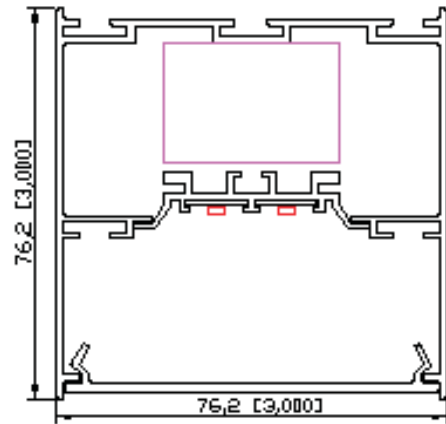

Lamp type: Suspended, Surface mounted, Trimless recessed mounted .

Input Voltage: 100-277V, LED Source: OSRAM 2835LED, Lumen:>105 lm/w Color tolerance<3.

Driver: built-in isolation driver, anti-flicker /0-10v dimming/ triac dimmer/DALI dimming

Structure: Split type lamp meets all kinds of construction requirements.

Optics: Imported frosted pc diffuser with inner stripe, anti-glare.

Shell: 6063-T5 Aluminum Colors (black, white) and sizes can be customized.

Life span up to 50000 hours, warranty for 5 years.

Certificates: cETLS,CE,SAA,CCC,DLC

Item number	Power	TCC	Flux(lm)	Dimension	Master carton dimension	QTY
LS7676-06T15	15W		1620lm	600mmx76mmx76mm	630mmx290mmx200mm	
LS7676-12T30	30W	3000K	3240lm	1200mmx76mmx76mm	1230mmx290mmx200mm	
LS7676-15T38	38W	4000K	4104lm	1500mmx76mmx76mm	1530mmx290mmx200mm	4
LS7676-18T45	45W	5000K	4860lm	1800mmx76mmx76mm	1830mmx290mmx200mm	
LS7676-24T60	60W	6000K	6480lm	2400mmx76mmx76mm	2430mmx290mmx200mm	

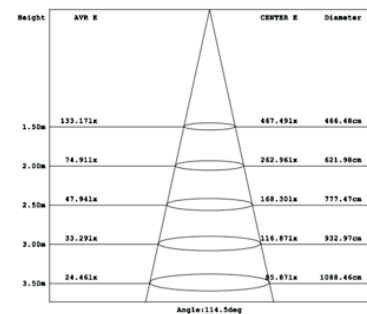
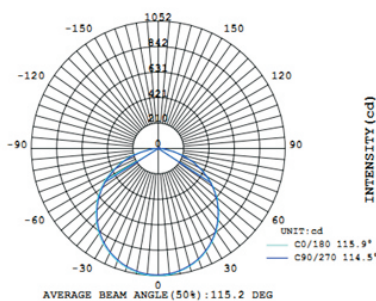
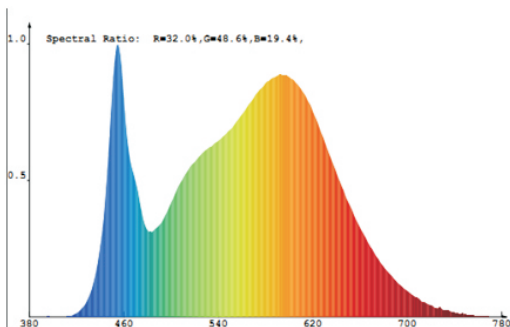

LS10176 Linear light

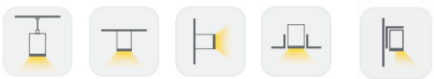
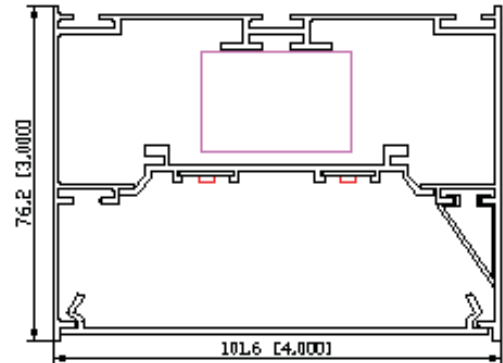
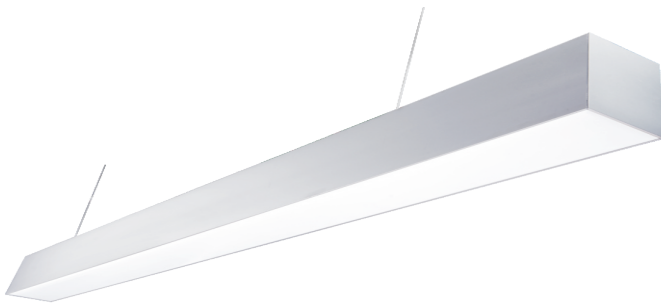

Lamp type: Suspended, Surface mounted, Trimless recessed mounted .

Input Voltage: 100-277V, LED Source: OSRAM 2835LED, Lumen:>105 lm/w Color tolerance<3.

Driver: built-in isolation driver, anti-flicker /0-10v dimming/ triac dimmer/DALI dimming

Structure: Split type lamp meets all kinds of construction requirements.

Optics: Imported frosted pc diffuser with inner stripe, anti-glare.

Shell: 6063-T5 Aluminum Colors (black, white) and sizes can be customized.

Life span up to 50000 hours, warranty for 5 years.

Certificates: cETLS,CE,SAA,CCC,DLC

Item number	Power	TCC	Flux(lm)	Dimension	Master carton dimension	QTY
LS10176-06T20	20W		2100lm	600mmx101mmx76mm	630mmx290mmx200mm	
LS10176-12T40	40W	3000K	4200lm	1200mmx101mmx76mm	1230mmx290mmx200mm	
LS10176-15T50	50W	4000K 5000K	5250lm	1500mmx101mmx76mm	1530mmx290mmx200mm	4
LS10176-18T60	60W	6000K	6300lm	1800mmx101mmx76mm	1830mmx290mmx200mm	
LS10176-24T80	80W		8400lm	2400mmx101mmx76mm	2430mmx290mmx200mm	

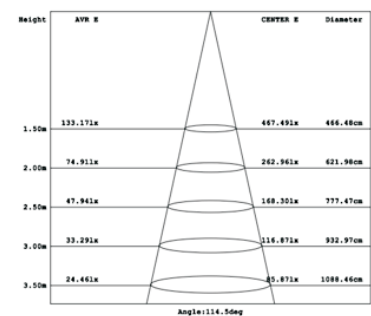
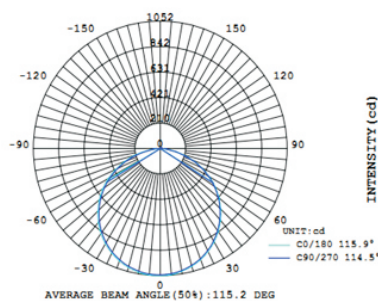
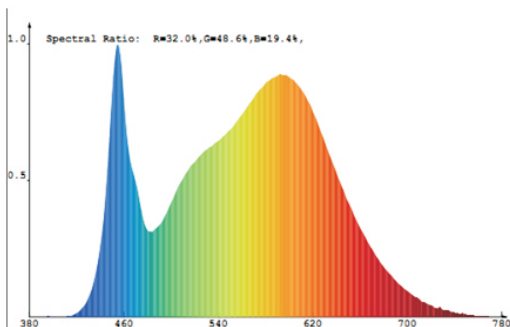

PGL10176 Linear light

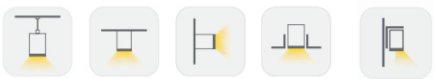
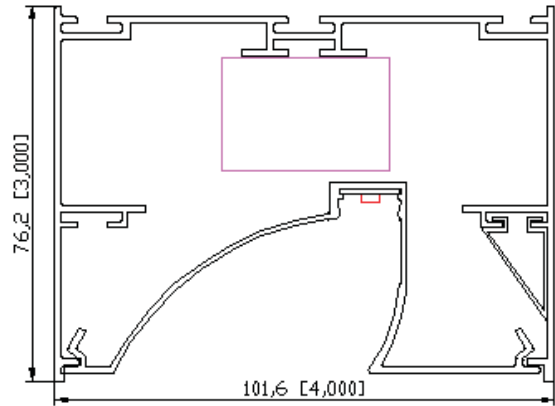

Lamp type: Suspended, Surface mounted, Trimless recessed mounted .

Input Voltage: 100-277V, LED Source: OSRAM 2835LED, Lumen:>80 lm/w Color tolerance<3.

Driver: built-in isolation driver, anti-flicker /0-10v dimming/ triac dimmer/DALI dimming

Structure: Split type lamp meets all kinds of construction requirements.

Optics: Imported frosted pc diffuser with inner stripe, anti-glare.

Shell: 6063-T5 Aluminum Colors (black, white) and sizes can be customized.

Life span up to 50000 hours, warranty for 5 years.

Certificates: cETLS,CE,SAA,CCC,

Item number	Power	TCC	Flux(lm)	Dimension	Master carton dimension	QTY
PGL10176-06T20	20W		1600lm	600mmx101mmx76mm	630mmx290mmx200mm	
PGL10176-12T40	40W	3000K	3200lm	1200mmx101mmx76mm	1230mmx290mmx200mm	
PGL10176-15T50	50W	4000K	4000lm	1500mmx101mmx76mm	1530mmx290mmx200mm	4
PGL10176-18T60	60W	5000K	4800lm	1800mmx101mmx76mm	1830mmx290mmx200mm	
PGL10176-24T80	80W	6000K	6400lm	2400mmx101mmx76mm	2430mmx290mmx200mm	

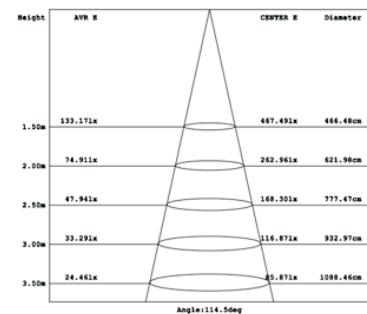
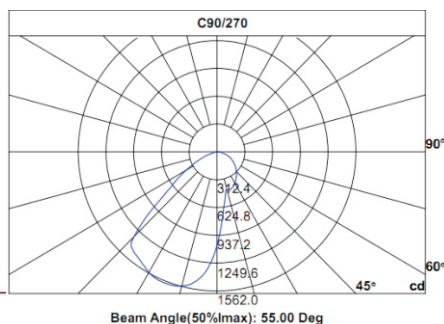
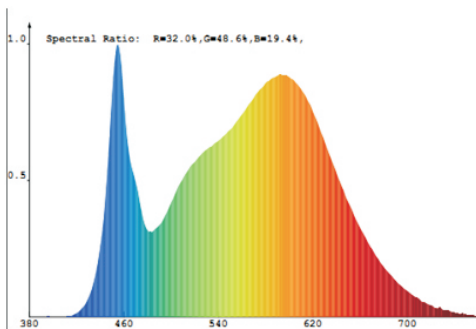

LS15055 Linear light

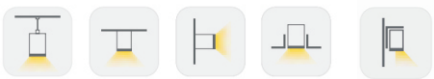
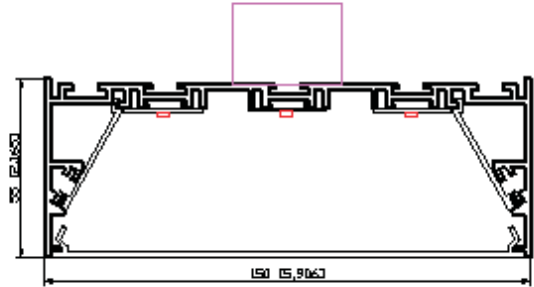
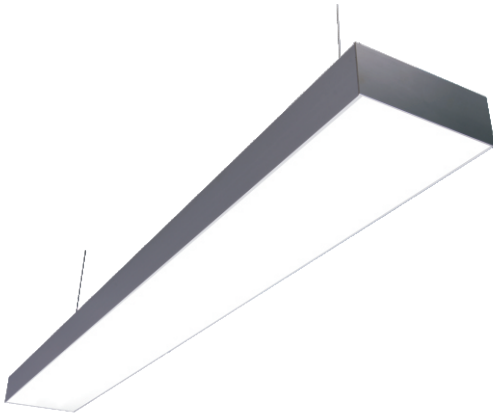

Lamp type: Suspended, Surface mounted, Trimless recessed mounted .

Input Voltage: 100-277V, LED Source: OSRAM 2835LED, Lumen:>105 lm/w Color tolerance<3.

Driver: built-in isolation driver, anti-flicker /0-10v dimming/ triac dimmer/DALI dimming

Structure: Split type lamp meets all kinds of construction requirements.

Optics: Imported frosted pc diffuser with inner stripe, anti-glare.

Shell: 6063-T5 Aluminum Colors (black, white) and sizes can be customized.

Life span up to 50000 hours, warranty for 5 years.

Certificates: CE,SAA,CCC,

Item number	Power	TCC	Flux(lm)	Dimension	Master carton dimension	QTY
LS15055-06T25	25W		2625lm	600mmx150mmx55mm	630mmx290mmx200mm	
LS15055-12T50	50W	3000K	5250lm	1200mmx150mmx55mm	1230mmx290mmx200mm	
LS15055-15T63	63W	4000K	6615lm	1500mmx150mmx55mm	1530mmx290mmx200mm	4
LS15055-18T75	75W	5000K	7875lm	1800mmx150mmx55mm	1830mmx290mmx200mm	
LS15055-24T100	100W	6000K	10500lm	2400mmx150mmx55mm	2430mmx290mmx200mm	

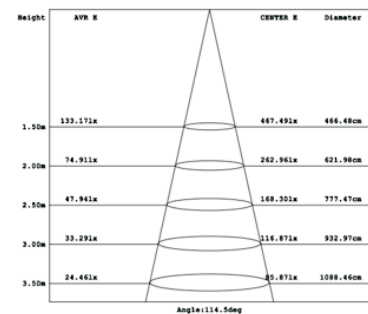
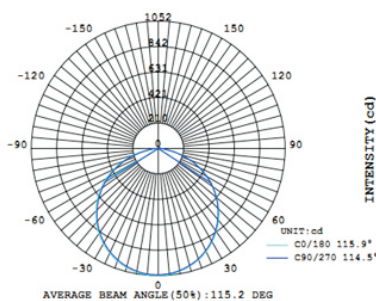
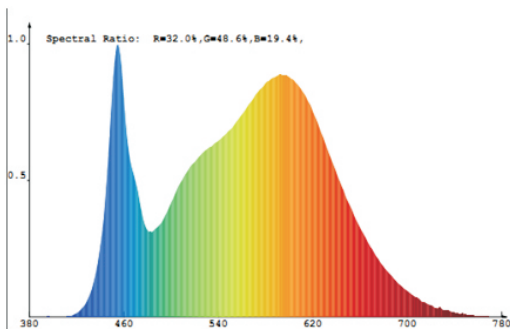

LS20076 Linear light

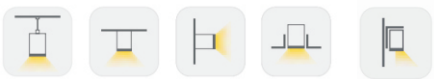
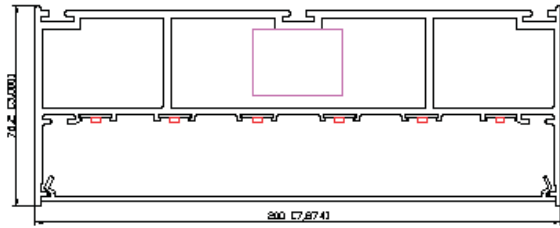

Lamp type: Suspended, Surface mounted, Trimless recessed mounted .

Input Voltage: 100-277V, LED Source: OSRAM 2835LED, Lumen:>105 lm/w Color tolerance<3.

Driver: built-in isolation driver, anti-flicker /0-10v dimming/ triac dimmer/DALI dimming

Structure: Split type lamp meets all kinds of construction requirements.

Optics: Imported frosted pc diffuser with inner stripe, anti-glare.

Shell: 6063-T5 Aluminum Colors (black, white) and sizes can be customized.

Life span up to 50000 hours, warranty for 5 years.

Certificates: CE,SAA,CCC

Item number	Power	TCC	Flux(lm)	Dimension	Master carton dimension	QTY
LS20076-06T25	25W		2625lm	600mmx200mmx76mm	630mmx290mmx200mm	
LS20076-12T50	50W	3000K	5250lm	1200mmx200mmx76mm	1230mmx290mmx200mm	
LS20076-15T63	63W	4000K	6615lm	1500mmx200mmx76mm	1530mmx290mmx200mm	2
LS20076-18T75	75W	5000K	7875lm	1800mmx200mmx76mm	1830mmx290mmx200mm	
LS20076-24T100	100W	6000K	10500lm	2400mmx200mmx76mm	2430mmx290mmx200mm	

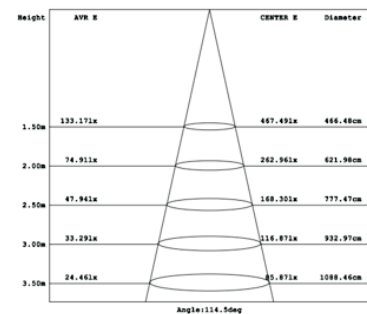
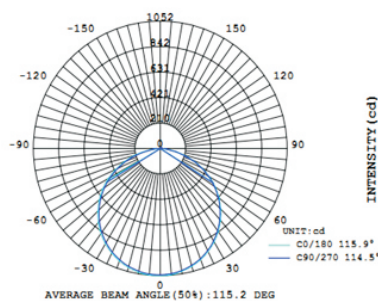
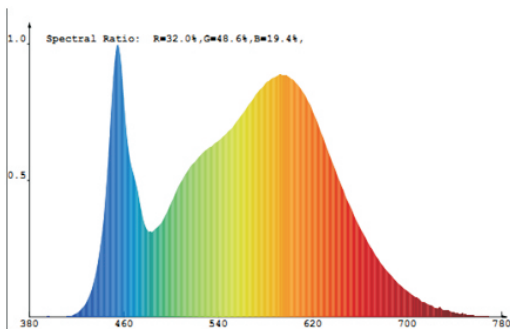

LS3050M Linear light

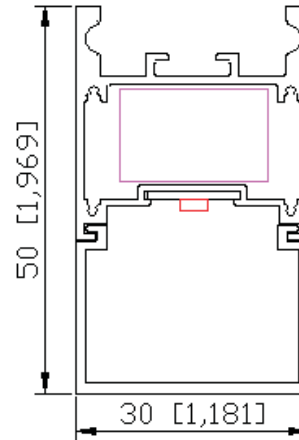

Lamp type: Suspended, Surface mounted,

Input Voltage: 100-277V, LED Source: OSRAM 2835LED, Lumen: >85 lm/w Color tolerance <3.

Driver: built-in isolation driver, anti-flicker /0-10v dimming/ triac dimmer/DALI dimming

Structure: Split type lamp meets all kinds of construction requirements.

Optics: Imported frosted pc diffuser with inner stripe, anti-glare.

Shell: 6063-T5 Aluminum Colors (black, white) and sizes can be customized.

Life span up to 30000 hours, warranty for 3 years.

Certificates: CE, SAA, CCC.

Item number	Power	TCC	Flux(lm)	Dimension	Master carton dimension	QTY
LS3050M-06T10	10W		850lm	600mmx30mmx50mm	630mmx290mmx200mm	
LS3050M-12T20	20W	3000K	1700lm	1200mmx30mmx50mm	1230mmx290mmx200mm	
LS3050M-15T25	25W	4000K	2150lm	1500mmx30mmx50mm	1530mmx290mmx200mm	12
LS3050M-18T30	30W	5000K	2550lm	1800mmx30mmx50mm	1830mmx290mmx200mm	
LS3050M-24T40	40W	6000K	4300lm	2400mmx30mmx50mm	2430mmx290mmx200mm	

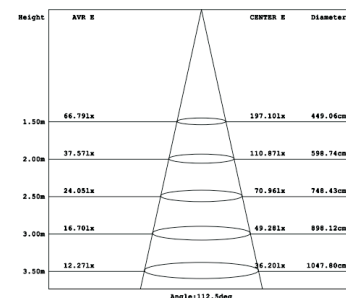
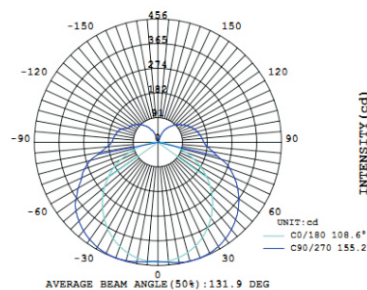
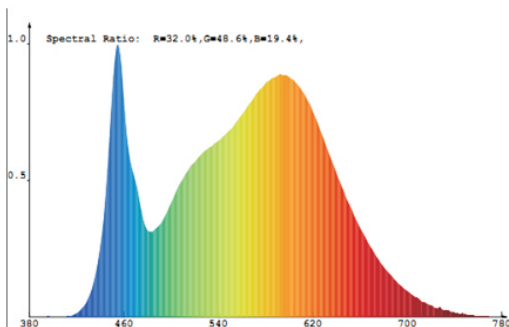

LS3560M Linear light

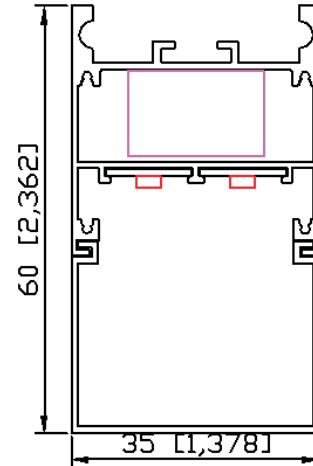

Lamp type: Suspended, Surface mounted,

Input Voltage: 100-277V, LED Source: OSRAM 2835LED, Lumen: >105 lm/w Color tolerance <3.

Driver: built-in isolation driver, anti-flicker /0-10v dimming/ triac dimmer/DALI dimming

Structure: Split type lamp meets all kinds of construction requirements.

Optics: Imported frosted pc diffuser with inner stripe, anti-glare.

Shell: 6063-T5 Aluminum Colors (black, white) and sizes can be customized.

Life span up to 30000 hours, warranty for 3 years.

Certificates: CE, SAA, CCC.

Item number	Power	TCC	Flux(lm)	Dimension	Master carton dimension	QTY
LS3560M-06T10	15W		1620lm	600mmx35mmx60mm	630mmx290mmx200mm	
LS3560M-12T20	30W	3000K	3240lm	1200mmx35mmx60mm	1230mmx290mmx200mm	
LS3560M-15T25	38W	4000K	4104lm	1500mmx35mmx60mm	1530mmx290mmx200mm	12
LS3560M-18T30	45W	5000K	4860lm	1800mmx35mmx60mm	1830mmx290mmx200mm	
LS3560M-24T40	60W	6000K	6480lm	2400mmx35mmx60mm	2430mmx290mmx200mm	

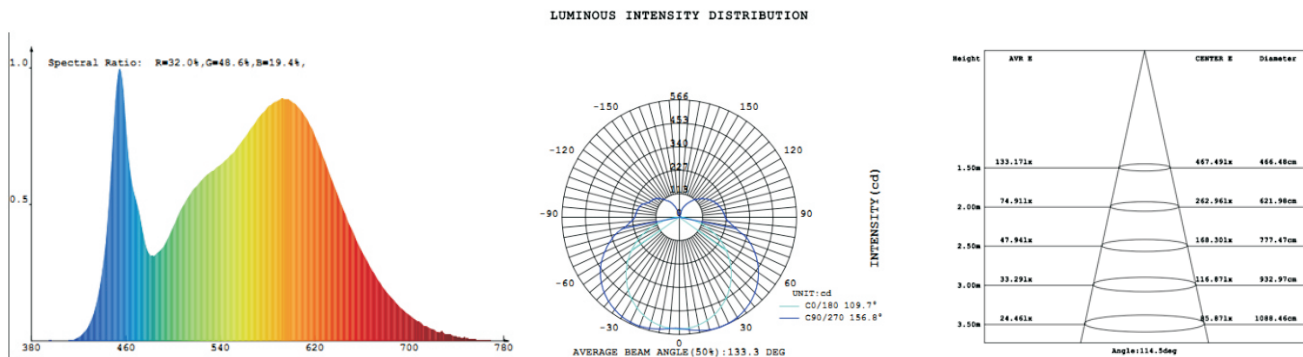

LE3833 Linear light

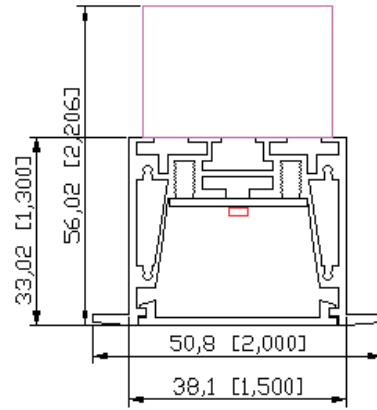

Lamp type: Recessed mounted . .

Input Voltage: 100-277V, LED Source: OSRAM 2835LED, Lumen:>105 lm/w Color tolerance<3.

Driver: built-in isolation driver, anti-flicker /0-10v dimming/ triac dimmer/DALI dimming

Structure: Split type lamp meets all kinds of construction requirements.

Optics: Imported frosted pc diffuser with inner stripe, anti-glare.

Shell: 6063-T5 Aluminum Colors (black, white) and sizes can be customized.

Life span up to 30000 hours, warranty for 3 years.

Certificates: CE,SAA,CCC.

Item number	Power	TCC	Flux(lm)	INSTALLATION WIDTH	Dimension	Master carton dimension	QTY
LS3833-06T15	15W		1620lm		600mmx50.8mmx33mm	630mmx290mmx200mm	
LS3833-12T30	30W	3000K	3240lm		1200mmx50.8mmx33mm	1230mmx290mmx200mm	
LS3833-15T38	38W	4000K	4104lm	39mm	1500mmx50.8mmx33mm	1530mmx290mmx200mm	9
LS3833-18T45	45W	5000K	4860lm		1800mmx50.8mmx33mm	1830mmx290mmx200mm	
LS3833-24T60	60W	6000K	6480lm		2400mmx50.8mmx33mm	2430mmx290mmx200mm	

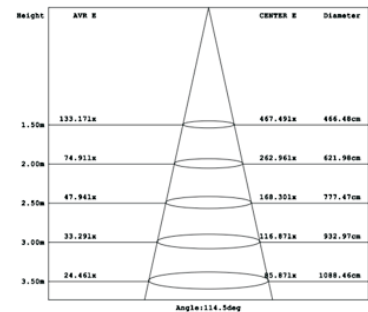
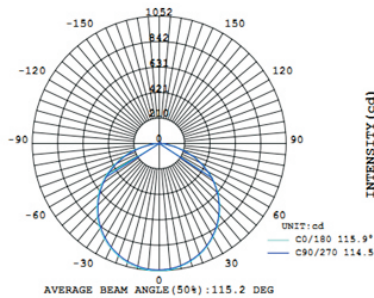
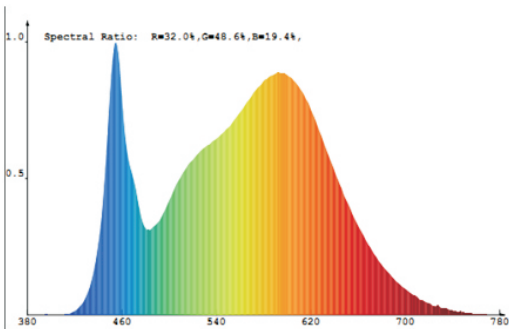

LE5038 Linear light

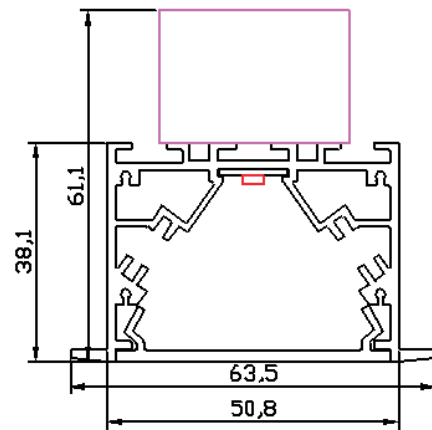
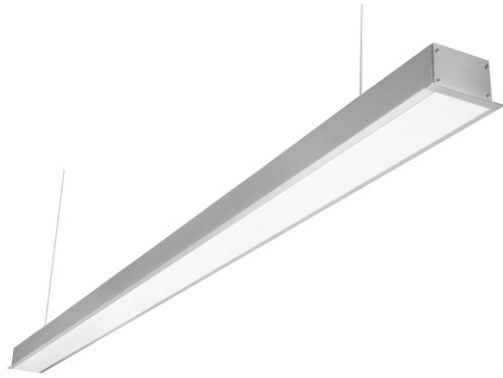

Lamp type: Recessed mounted . .

Input Voltage: 100-277V, LED Source: OSRAM 2835LED, Lumen:>105 lm/w Color tolerance<3.

Driver: built-in isolation driver, anti-flicker /0-10v dimming/ triac dimmer/DALI dimming

Structure: Split type lamp meets all kinds of construction requirements.

Optics: Imported frosted pc diffuser with inner stripe, anti-glare.

Shell: 6063-T5 Aluminum Colors (black, white) and sizes can be customized.

Life span up to 30000 hours, warranty for 3 years.

Certificates: CE,SAA,CCC.

Item number	Power	TCC	Flux(lm)	INSTALLATION WIDTH	Dimension	Master carton dimension	QTY
LS5038-06T15	15W		1620lm		600mmx63.5mmx38mm	630mmx290mmx200mm	
LS5038-12T30	30W	3000K	3240lm		1200mmx63.5mmx38mm	1230mmx290mmx200mm	
LS5038-15T38	38W	4000K	4104lm	51mm	1500mmx63.5mmx38mm	1530mmx290mmx200mm	6
LS5038-18T45	45W	5000K	4860lm		1800mmx63.5mmx38mm	1830mmx290mmx200mm	
LS5038-24T60	60W	6000K	6480lm		2400mmx63.5mmx38mm	2430mmx290mmx200mm	

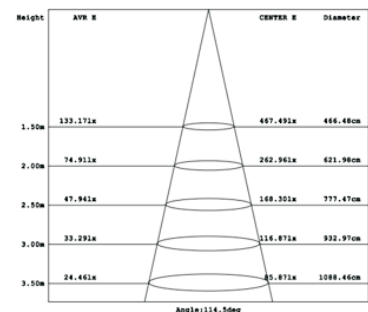
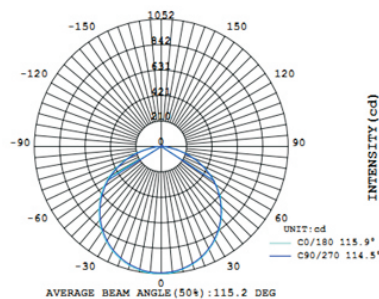
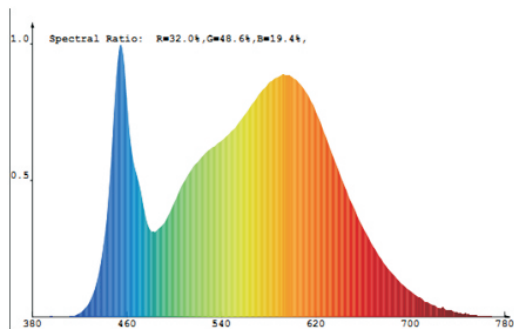

LE6350 Linear light

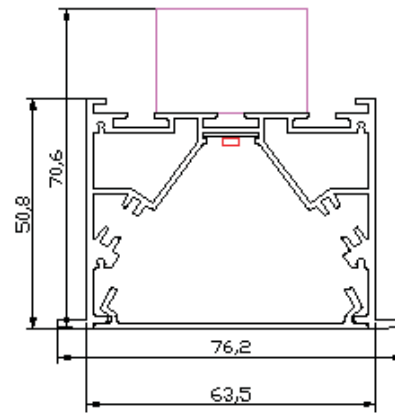
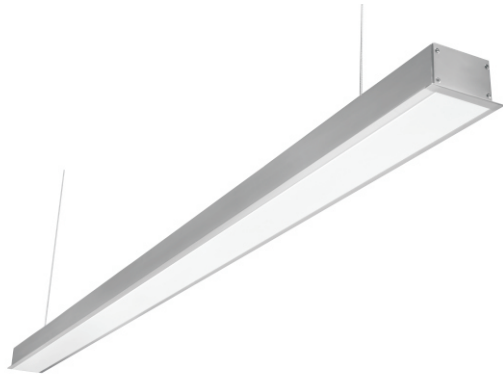

Lamp type: Recessed mounted . .

Input Voltage: 100-277V, LED Source: OSRAM 2835LED, Lumen:>105 lm/w Color tolerance<3.

Driver: built-in isolation driver, anti-flicker /0-10v dimming/ triac dimmer/DALI dimming

Structure: Split type lamp meets all kinds of construction requirements.

Optics: Imported frosted pc diffuser with inner stripe, anti-glare.

Shell: 6063-T5 Aluminum Colors (black, white) and sizes can be customized.

Life span up to 30000 hours, warranty for 3 years.

Certificates: CE,SAA,CCC.

Item number	Power	TCC	Flux(lm)	INSTALLATION WIDTH	Dimension	Master carton dimension	QTY
LS6350-06T15	15W		1620lm		600mmx76.2mmx51mm	630mmx290mmx200mm	
LS6350-12T30	30W	3000K	3240lm		1200mmx76.2mmx51mm	1230mmx290mmx200mm	
LS6350-15T38	38W	4000K	4104lm	64mm	1500mmx76.2mmx51mm	1530mmx290mmx200mm	6
LS6350-18T45	45W	5000K	4860lm		1800mmx76.2mmx51mm	1830mmx290mmx200mm	
LS6350-24T60	60W	6000K	6480lm		2400mmx76.2mmx51mm	2430mmx290mmx200mm	

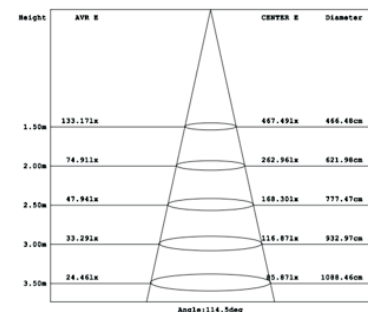
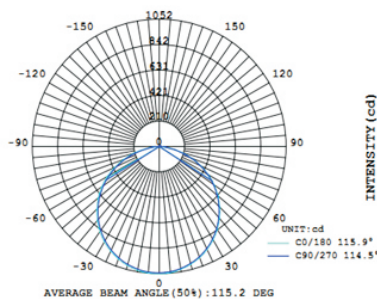
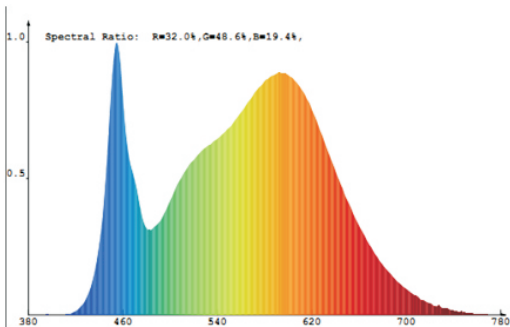

LE7676 Linear light

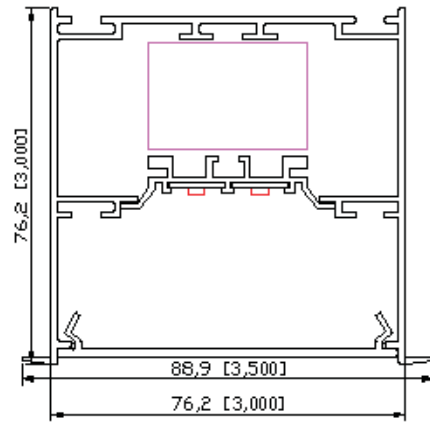

Lamp type: Recessed mounted . .

Input Voltage: 100-277V, LED Source: OSRAM 2835LED, Lumen:>105 lm/w Color tolerance<3.

Driver: built-in isolation driver, anti-flicker /0-10v dimming/ triac dimmer/DALI dimming

Structure: Split type lamp meets all kinds of construction requirements.

Optics: Imported frosted pc diffuser with inner stripe, anti-glare.

Shell: 6063-T5 Aluminum Colors (black, white) and sizes can be customized.

Life span up to 30000 hours, warranty for 3 years.

Certificates: cETLs,DLC,CE,SAA,CCC.

Item number	Power	TCC	Flux(lm)	INSTALLATION WIDTH	Dimension	Master carton dimension	QTY
LS7676-06T15	15W		1620lm		600mmx89mmx76mm	630mmx290mmx200mm	
LS7676-12T30	30W	3000K	3240lm		1200mmx89mmx76mm	1230mmx290mmx200mm	
LS7676-15T38	38W	4000K	4104lm	77mm	1500mmx89mmx76mm	1530mmx290mmx200mm	4
LS7676-18T45	45W	5000K	4860lm		1800mmx89mmx76mm	1830mmx290mmx200mm	
LS7676-24T60	60W	6000K	6480lm		2400mmx89mmx76mm	2430mmx290mmx200mm	

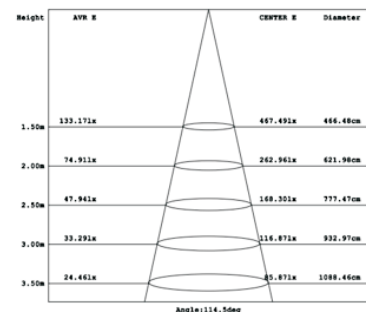
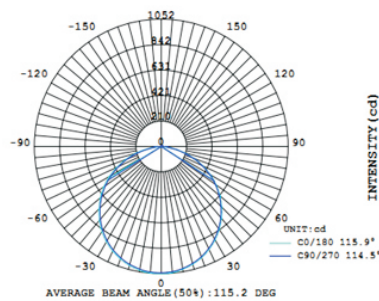
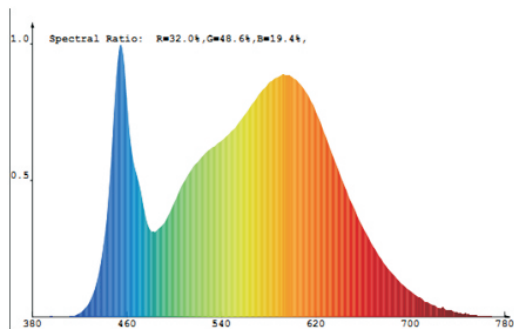

LE10176 Linear light

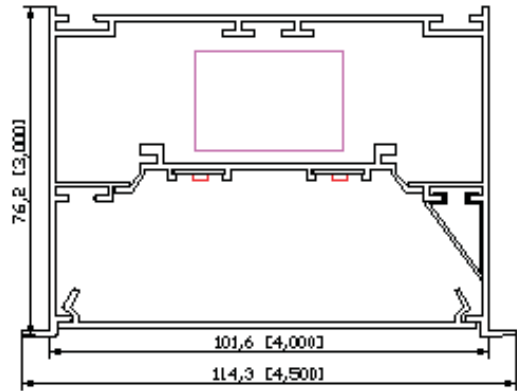
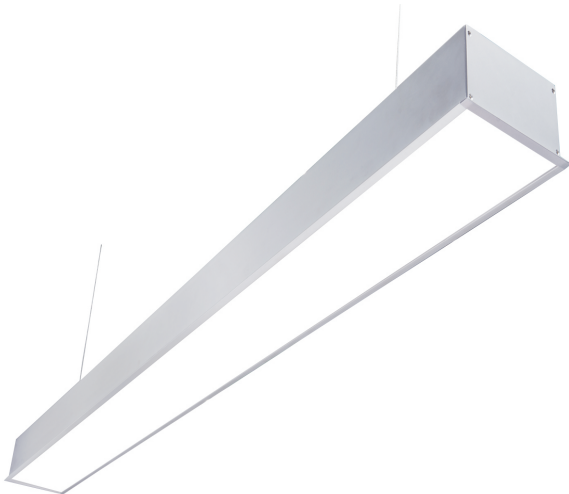

Lamp type: Recessed mounted . .

Input Voltage: 100-277V, LED Source: OSRAM 2835LED, Lumen:>105 lm/w Color tolerance<3.

Driver: built-in isolation driver, anti-flicker /0-10v dimming/ triac dimmer/DALI dimming

Structure: Split type lamp meets all kinds of construction requirements.

Optics: Imported frosted pc diffuser with inner stripe, anti-glare.

Shell: 6063-T5 Aluminum Colors (black, white) and sizes can be customized.

Life span up to 30000 hours, warranty for 3 years.

Certificates: cETLs,DLC,CE,SAA,CCC.

Item number	Power	TCC	Flux(lm)	INSTALLATION WIDTH	Dimension	Master carton dimension	QTY
LE10176-06T20	20W		2100lm		600mmx114mmx76mm	630mmx290mmx200mm	
LE10176-12T40	40W	3000K	4200lm		1200mmx114mmx76mm	1230mmx290mmx200mm	
LE10176-15T50	50W	4000K	5250lm	102mm	1500mmx114mmx76mm	1530mmx290mmx200mm	4
LE10176-18T60	60W	5000K	6300lm		1800mmx114mmx76mm	1830mmx290mmx200mm	
LE10176-24T80	80W	6000K	8400lm		2400mmx114mmx76mm	2430mmx290mmx200mm	

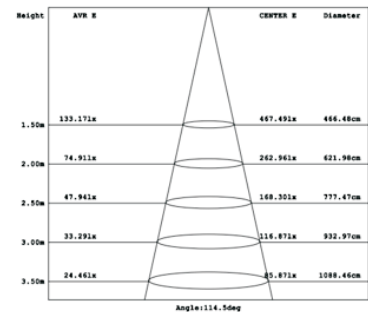
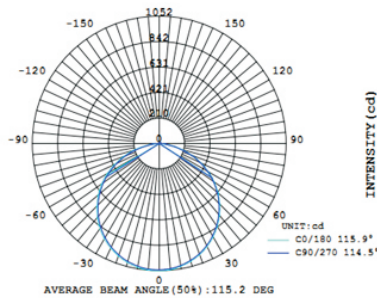
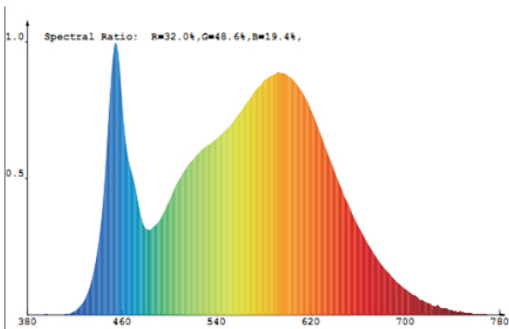

PGE10176 Linear light

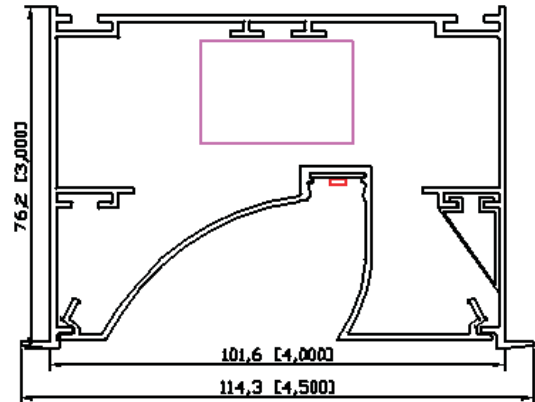
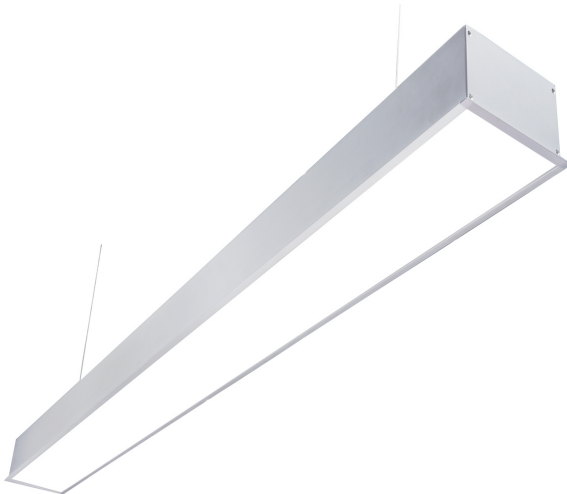

Lamp type: Recessed mounted . .

Input Voltage: 100-277V, LED Source: OSRAM 2835LED, Lumen:>80lm/w Color tolerance<3.

Driver: built-in isolation driver, anti-flicker /0-10v dimming/ triac dimmer/DALI dimming

Structure: Split type lamp meets all kinds of construction requirements.

Optics: Imported frosted pc diffuser with inner stripe, anti-glare.

Shell: 6063-T5 Aluminum Colors (black, white) and sizes can be customized.

Life span up to 30000 hours, warranty for 3 years.

Certificates: cETLs,CE,SAA,CCC.

Item number	Power	TCC	Flux(lm)	INSTALLATION WIDTH	Dimension	Master carton dimension	QTY
PGE10176-06T20	20W		1600lm		600mmx114mmx76mm	630mmx290mmx200mm	
PGE10176-12T40	40W	3000K	3200lm		1200mmx114mmx76mm	1230mmx290mmx200mm	
PGE10176-15T50	50W	4000K	4000lm	102mm	1500mmx114mmx76mm	1530mmx290mmx200mm	4
PGE10176-18T60	60W	5000K	4800lm		1800mmx114mmx76mm	1830mmx290mmx200mm	
PGE10176-24T80	80W	6000K	6400lm		2400mmx114mmx76mm	2430mmx290mmx200mm	

